

Installation and User's Guide



EN

DE

FR

NL

IMPORTANT SAFETY INFORMATION:

Read this manual first before attempting to install or use this electric fire. Always comply with the warnings and safety instructions contained in this manual and presented on the appliance to prevent personal injury or property damage.

The product complies with the required Product Safety, Electromagnetic Compatibility and Environmental Standards. This product is fully compliant with LVD, EMC, RoHs and EcoDesign Directives.



EN: This product is only suitable for well insulated rooms or occasional use. DE: Dieses Produkt ist nur für gut isolierte Bereiche oder gelegentliche Verwendung geeignet. FR: Ce produit convient uniquement à des endroits bien isolés ou pour un usage occasionnel. IT: Questo prodotto è adatto solo per spazi ben isolati o per uso occasionale. ES: Este producto sólo es adecuado para espacios bien aislados o un uso ocasional. NL: Dit product is uitsluitend geschikt voor goed geïsoleerde ruimten of voor sporadisch gebruik. PL: Produkt ten jest odpowiedni wyłącznie do dobrze odizolowanych miejsc lub do okazjonalnego uytku. NO: Dette produktet egner seg kun for godt isolerte rom eller sporadisk bruk. RO: Acest produs este adecvat exclusiv spațiilor bine ventilate sau utilizării ocazionale. CZ: Tento výrobek je vhodný pouze do dobře izolovaných prostor nebo k příležitostnému použití. DK: Dette produkt er kun egnet til velisolerede rum eller lejlighedsvis brug. PT: Este produto somente é adequado para espaços bem isolados ou uso ocasional. SE: Denna produkt är endast avsedd för välisolerade utrymmen eller tillfällig användning. FI: Tämä tuote soveltuu ainoastaan hyvin eristettyihin tiloihin tai satunnaiseen käyttöön. SK: Tento výrobok je vhodný len pre dobre izolované priestory alebo na obasnú použitie. SI: Ta izdelek je primeren le za dobro izolirane prostore ali za obasno uporabo. HR: Ovaj proizvod je pogodan samo za dobro izolirane prostore ili povremenu upotrebu. HU: Ez a termék csak jól szigetelt terekhez vagy eseti használatra alkalmas



INSTALLER: LEAVE THIS MANUAL WITH THE APPLIANCE.
CONSUMER: RETAIN THIS MANUAL FOR FUTURE REFERENCE

Table of Contents

Welcome	3
 IMPORTANT INSTRUCTIONS	4
Technical Specifications	6
Electrical Requirements	6
Technical Information	6
Product Dimensions	6
Package Contents	7
Optional Accessories	8
Installation	9
Placement	9
Installation Instructions	10
Electrical Installation	12
Heater Hardware Disconnect	13
Mirrored Glass Installation	14
Media Arrangement	15
Front Glass Installation	16
Operation	17
General Operation	17
Hidden Touch Controls	17
Remote Operation	17
App	17
Maintenance	20
Remote Control Battery Replacement	20
Cleaning	20
Servicing	20
Troubleshooting	21

Welcome

MODEL NUMBER AND SERIAL NUMBER

Please record your model and serial numbers for future reference.

Model _____

Serial Number _____

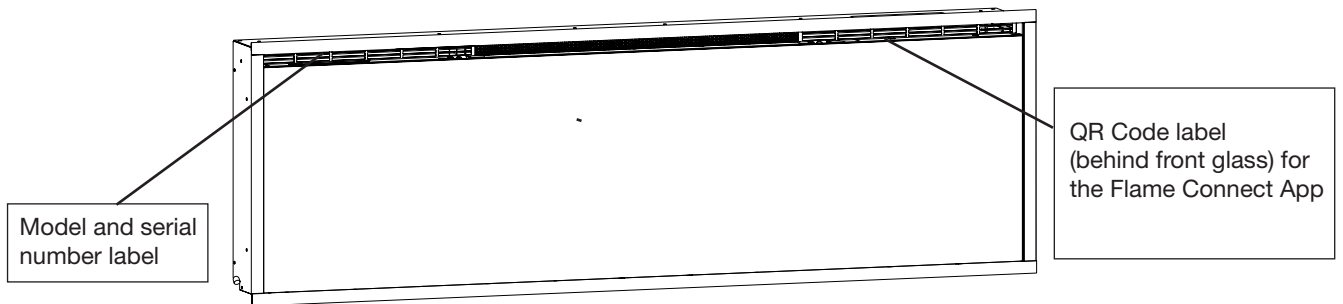

SAVE THESE INSTRUCTIONS

IMPORTANT INSTRUCTIONS

CAUTION: FAILURE TO FOLLOW THESE INSTRUCTIONS MAY CAUSE INJURY AND/OR DAMAGE AND MAY INVALIDATE YOUR GUARANTEE

Important Safety Advice

When using electrical appliances, basic precautions should always be followed to reduce the risk of fire, electrical shock and injury to persons, including the following:

- If the appliance is damaged, check with the supplier before installation and operation.
- Do not use outdoors.
- Do not use in the immediate surroundings of a bath, shower or swimming pool.
- Do not locate the appliance immediately below a fixed socket outlet or connection box.

Warning: This heater must not be used for anything other than normal domestic household purposes in the country where it was purchased from a recognised commercial retailer.

Do not use this heater if it has been dropped

Do not use if there are visible signs of damage to the heater.

Use this heater on a horizontal and stable surface, or fix it to the wall, as applicable.

Children of less than 3 years should be kept away unless continuously supervised. Children aged from 3 years and less than 8 years shall only switch on/off the appliance provided that it has been placed or installed in its intended normal operating position and they have been given supervision or instruction concerning use of the appliance in a safe way and understanding the hazards involved. Children aged from 3 years and less than 8 years shall not plug in, regulate and clean the appliance or perform user maintenance.

CAUTION: Some parts of this product can be very hot and cause burns. Particular attention has to be given where children and vulnerable people are present.

This appliance can be used by children aged from 8 years and above and persons with reduced physical, sensory or mental capabilities or lack of experience and knowledge if they have been given supervision or instruction concerning use of the appliance in a safe way and understand the hazards involved. Children shall not play with the appliance. Cleaning and user maintenance shall not be made by Children without supervision.

Warning: Do not use this heater in small rooms when they are occupied by persons not capable of leaving the room on their own, unless constant supervision is provided.

Warning: In order to avoid overheating, do not cover the appliance. Do not place material or garments on the appliance, or obstruct the air circulation around the appliance, for instance by curtains or furniture, as this could cause overheating and a fire risk.

The appliance carries a "Do Not Cover" warning. 

Warning: To reduce the risk of fire, keep textiles, curtains, or any other flammable material a minimum distance of 1m from the air outlet.

Warning: In order to avoid a hazard due to inadvertent resetting of the thermal cut-out, this appliance must not be supplied through an external switching device, such as a timer, or connected to a circuit that is regularly switched on and off by the utility.

IMPORTANT INSTRUCTIONS

WARNING: KEEP BATTERIES OUT OF REACH OF CHILDREN

- Swallowing may lead to serious injury in as little as 2 hours or death, due to chemical burns and potential perforation of the oesophagus.
- If you think batteries might have been swallowed or placed inside any part of the body seek immediate medical attention
- Examine devices and make sure the battery compartment is correctly secured, e.g. that the screw or other mechanical fastener is tightened. Do not use if the compartment is not secure.
- Dispose of used button batteries immediately and safely. Flat batteries can still be dangerous.

CAUTION: No obvious symptoms

Unfortunately, it is not obvious when a button or coin battery is stuck in a child's oesophagus (food pipe).

There are no specific symptoms associated with this. The child might:

- cough, gag or drool a lot;
- appear to have a stomach upset or a virus;
- be sick;
- point to their throat or stomach;
- have a pain in their abdomen, chest or throat;
- be tired or lethargic;
- be quieter or more clingy than usual or otherwise "not themselves";
- lose their appetite or have a reduced appetite; and
- not want to eat solid food/be unable to eat solid food.

These sorts of symptoms vary or fluctuate, with the pain increasing and then subsiding.

A specific symptom to button and coin battery ingestion is vomiting fresh (bright red) blood. If the child does this seek immediate medical help.

- The lack of clear symptoms is why it is important to be vigilant with "flat" or spare button or coin batteries in the home and the products that contain them.



WARNING

KEEP OUT OF REACH OF CHILDREN

Swallowing can lead to chemical burns, perforation of soft tissue, and death. Severe burns can occur within 2 hours of ingestion. Seek medical attention immediately.



Technical Specifications

Electrical Requirements

⚠ WARNING: Construction and wiring must comply with local building codes and other applicable regulations to reduce the risk of fire, electric shock and injury to persons.

⚠ WARNING: To reduce the risk of fire, electric shock or injury to persons, always use a licensed electrician.

! NOTE: A dedicated, properly fused 13 Amp circuit is required, rated for the appropriate voltage (230-240V). An isolation switch should also be incorporated in cases where the product plug is inaccessible after installation.

Technical Information

Rating : 230-240V~50Hz

Heat Output		230V	-	240V	
Nominal Heat Output	P_{Nom}	1.8	-	1.9	kW
Minimum Heat Output	P_{min}	0.9	-	0.9	kW
Maximum Continuous Heat Output	$P_{max,c}$	1.8	-	1.9	kW

Auxiliary Electricity Consumption

In Standby Mode	el_{SB}	0.5	-	0.5	W
-----------------	-----------	-----	---	-----	---







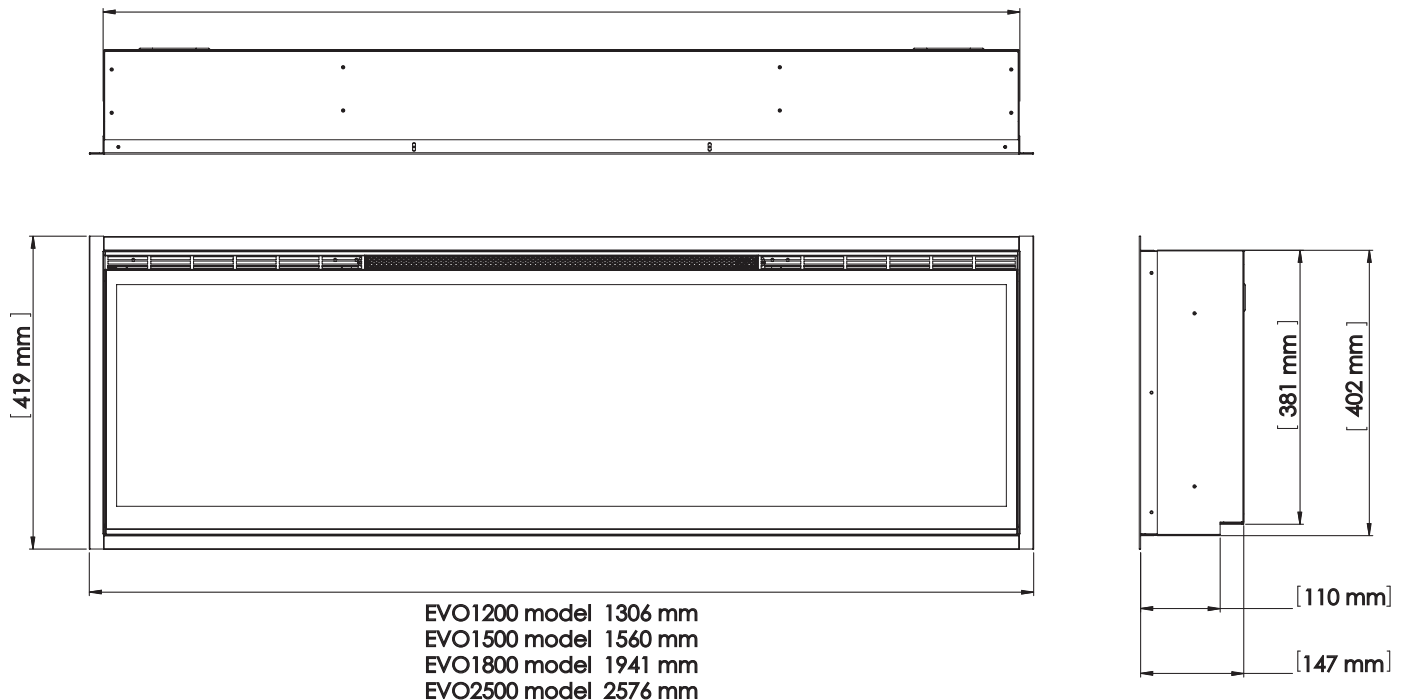

Product Dimensions

Figure 1

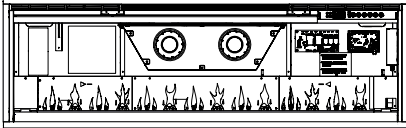

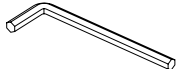
EVO1200 model 1278 mm
 EVO1500 model 1532 mm
 EVO1800 model 1887 mm
 EVO2500 model 2548 mm

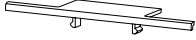

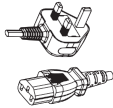
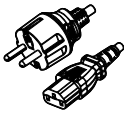
Package Contents

Image	Description	Quantity			
		EVO1200	EVO1500	EVO1800	EVO2500
	Remote Control	1	1	1	1
	Driftwood	8	10	12	16
	Tumbled Glass Embers	~2.6 lb ~1.2 kg	~3.3 lb ~1.5 kg	~3.9 lb ~1.8 kg	~5.2 lb ~2.4 kg
	Firebox	1	1	1	1
	Front Glass	1	1	1	1
	7.4x10 Hex Key	1	1	1	1
	Black Screws (M4x10, hex button head)	2	2	4	4
	Screw Covers	2	2	4	4
	Mirrored Glass	1	1	1	1
	UK Power Cord	1	1	1	1
	EU Power Cord	1	1	1	1

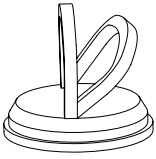
Package Contents

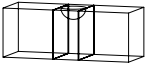
Image	Description	Quantity			
		EVO1200	EVO1500	EVO1800	EVO2500
	User's and Installation Guide	1	1	1	1
 <p><i>Do not dispose of the suction cup after installation. Keep it in a secure location as it will be helpful for maintenance and service of the unit.</i></p>	Suction Cup	0	1	1	1
	Wood Screws 38.1 mm	4	4	4	4
	Bubble Level	1	1	1	1

*Package contents are subject to change

Optional Accessories

Description	Model Number		
	EVO1200	EVO1500	EVO1800
Ignite Evolve Oak Logset	500003877	500003878	500003879

*Please contact your local Dimplex dealer for inquiries.

Installation

Placement

! **NOTE:** It is recommended that the bottom of the unit be mounted between 127 mm and 1016 mm from the ground to maintain an optimized viewing angle of the flame.

⚠ **WARNING:** The top of the fireplace must be installed a minimum of 610 mm from the ceiling.
The fireplace must be installed a minimum of 127 mm from the ground.

Wi-Fi

For installations where the use of the Flame Connect app is desired, ensure the fireplace is located within range of a Wi-Fi network.

Installation Recommendations for Overhanging Objects

For overhanging temperature-sensitive objects, such as a television, a mantel, or artwork, always follow the recommendations provided by its manufacturer for installation over a heater.

Figure 2 provides the overhang clearance recommendations for the fireplace. Areas above the fireplace are marked as follows:

- Light grey box (■) is subject to temperatures greater than 65°C.
- Dark grey box (■) is subject to temperatures greater than 40°C
- Clear box (□) is subject to temperatures less than 40°C

Figure 2

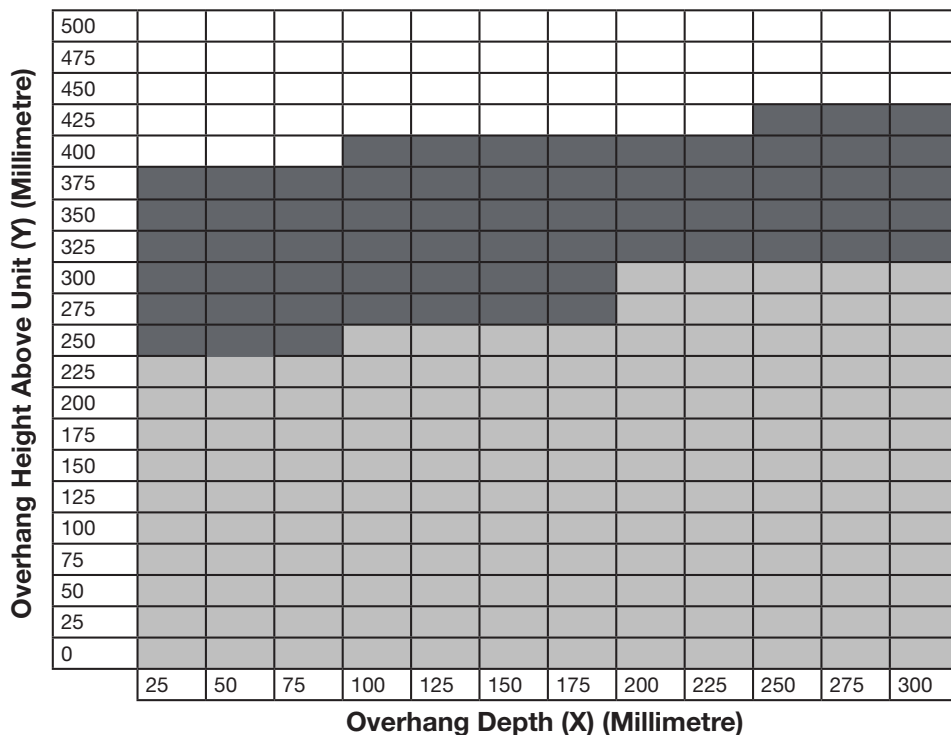

Installation

Installation Instructions

! **NOTE:** Two people are required for installation.

1. The fireplace is installed flush-mounted. (51 mm x 153 mm frame). Prepare a wall with a framed opening, following the dimensions shown in **Figure 3**.

⚠ **CAUTION:** Decorative finishing material (such as brick) should be limited to 13 mm overhang to ensure adequate flow of heated air out of the firebox area.

⚠ **CAUTION:** This fireplace is **NOT** load-bearing. Ensure the opening for the fireplace is framed in such a way that the weight of the building materials will not create pressure on the top of the fireplace.

Figure 3

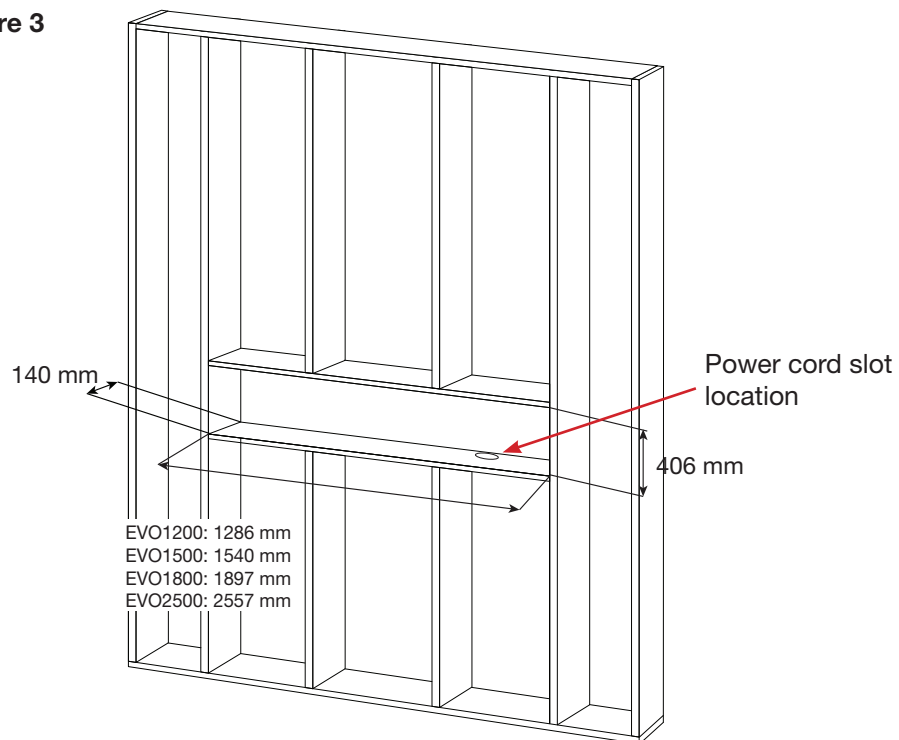

! **NOTE:** The power cord is located on the right side at the bottom of the firebox.

2. Create a slot in the framing to allow routing of the power cord to this location.

3. If a trimless installation is desired, remove the factory trim by removing the screws that secure it.

4. Lift the firebox into the opening in the frame using the handles on the back of the fireplace.

5. Using a bubble level (supplied) ensure that the fireplace is level within the framing. Adjust as required.

Installation

Distance from the right side to the power cord:

EVO1200, EVO1500, EVO1800

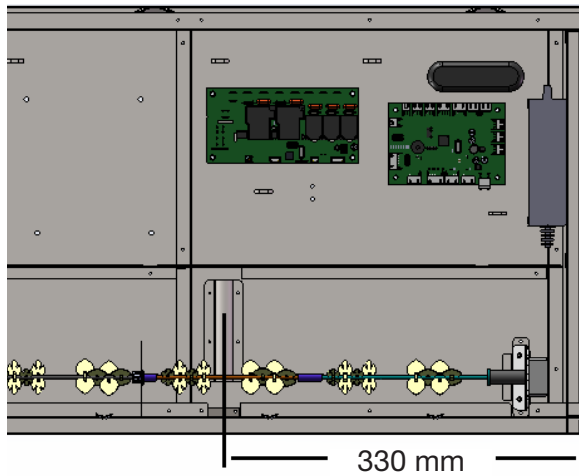

EVO2500

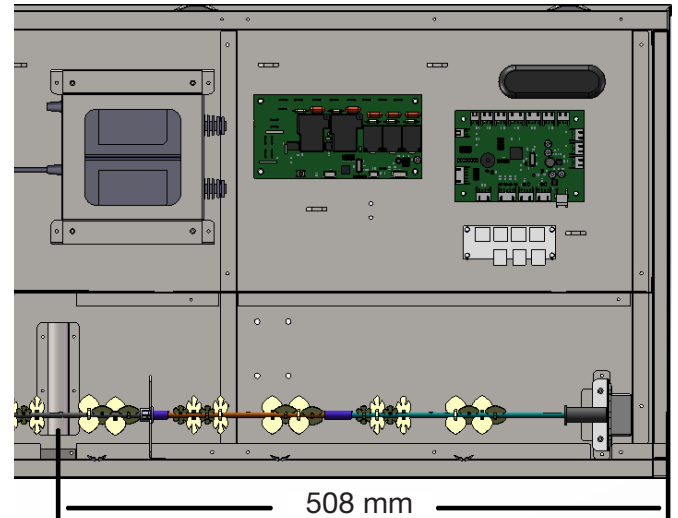

6. Drive four supplied mounting screws through the four mounting holes located on the inside surface of the fireplace chassis, into wall studs. (Figure 4)
7. Complete the electrical connection according to instructions in the *Electrical Installation* section (page 12).
8. Complete the installation using the instructions in the following sections: *Mirrored Glass Installation* (page 14), *Arranging Media* (page 15), *Front Glass Installation* (page 16).

! NOTE: Install the firebox flush with the surrounding wall/framing. The face of the firebox should not be recessed. Any overhang from the surrounding framing can result in an error with the heater.

Figure 4

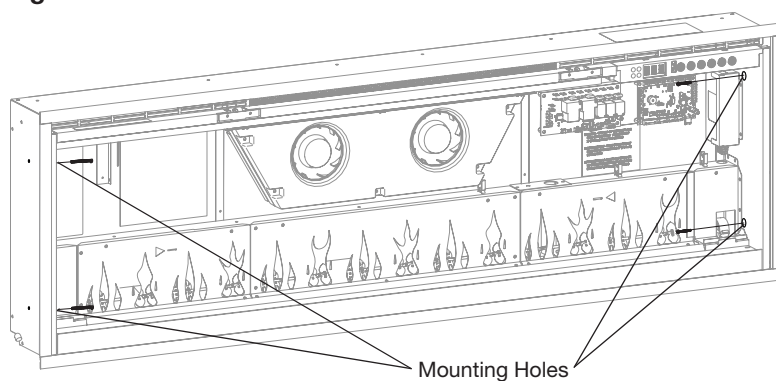

Installation

Electrical Installation

⚠ WARNING:

The installation of the electric fireplace must comply with the applicable Local and/or National Electrical Codes and utility requirements.

Use the appropriate cord to meet local and national electrical codes for rated power consumption.

⚠ CAUTION: A dedicated, properly fused 13 Amp circuit is required, rated for the appropriate voltage (230-240V). An isolation switch should also be incorporated in cases where the product plug is inaccessible after installation.

Power Cord Installation

! NOTE: Two power cords are provided (the EU or UK option) with the fireplace. Install the suitable power cord if the incorrect set came installed on the unit.

⚠ WARNING: This heater is not intended for use with an extension cord. Plug the power cord directly into an appropriate grounded receptacle.

Figure 5

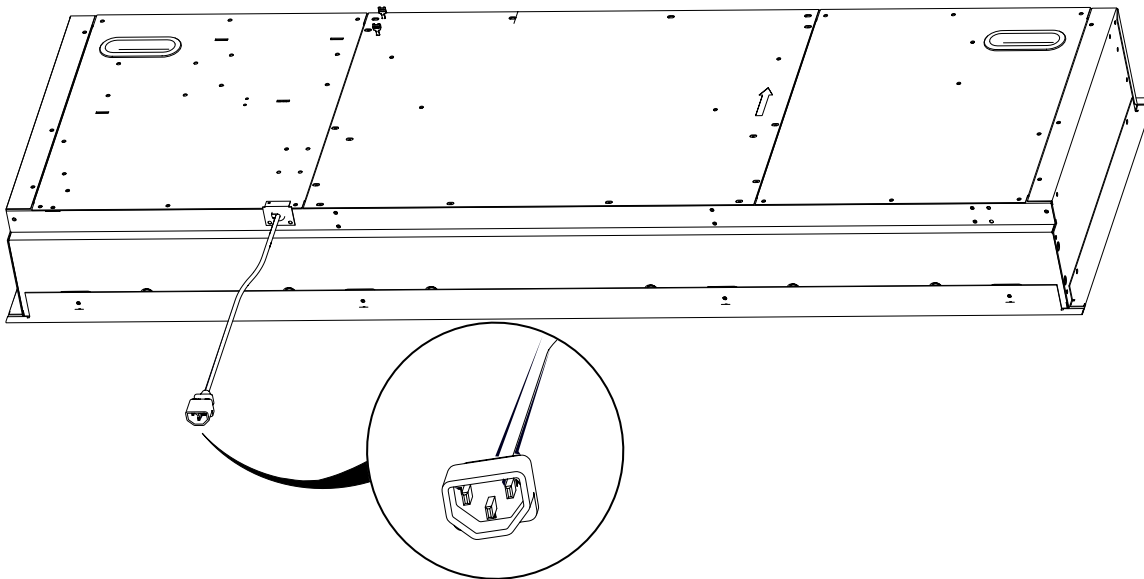
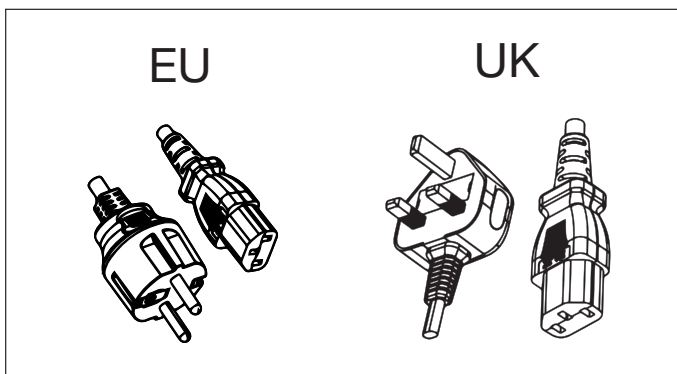

Figure 6



Installation

Heater Hardware Disconnect

The fireplace heater can be permanently disabled by removing the electronic jumper on the control board.

! NOTE: Heater hardware disconnect will permanently disable the heater and fan. Follow these instructions only when an installation without heat is required. Temporary disabling of the heater can be achieved through the hidden touch controls. See “Heat Disable” in *Operation* section (page 18) for instructions.

To disconnect the heater and fan permanently:

1. Locate the control board. The heater hardware disconnect jumper location is labeled “HEAT”. (Figure 7)
2. Pull out the heater hardware disconnect jumper. (Figure 8)

Figure 7

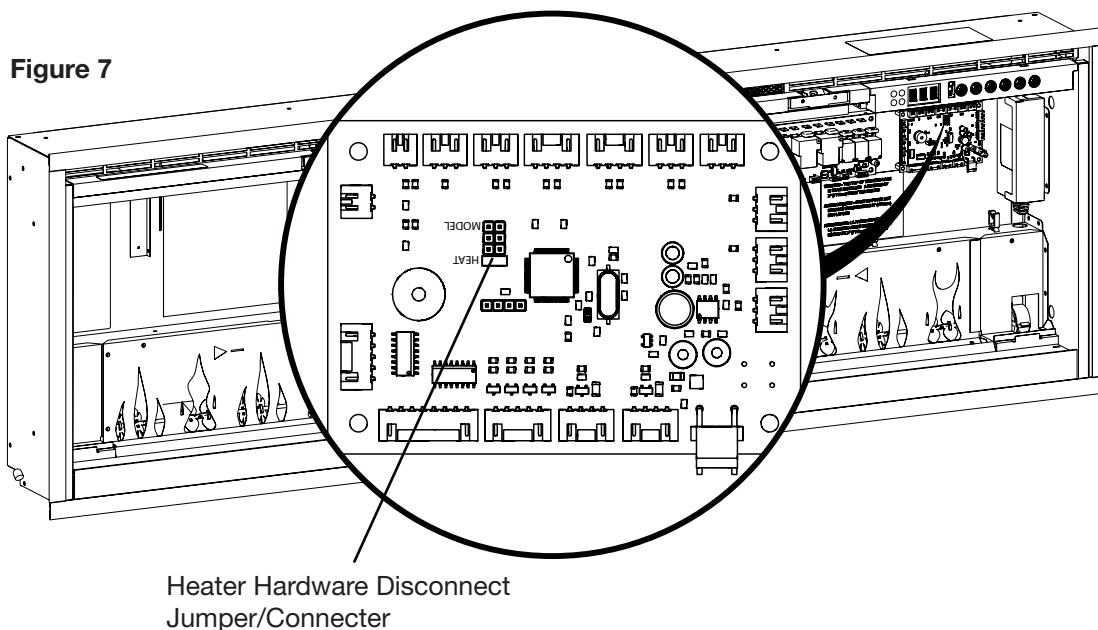
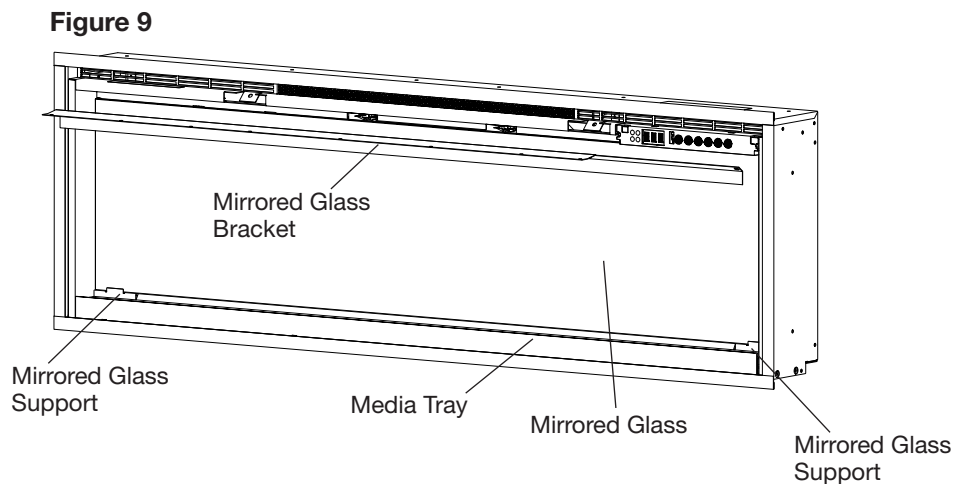

Figure 8



Mirrored Glass Installation

1. Locate and remove the screws securing the mirrored glass bracket to the unit, along the top of the opening, and set bracket and screws aside. (Figure 9)
 2. Remove the provided suction cup from the inside cavity of the unit (not included in **EVO1200** units).
 3. Ensure that the back of the glass is clean and free from particles and fingerprints.
 4. Secure the suction cup to the mirrored glass on the reflective side
 5. Lift the mirrored glass and place it into the supports on the bottom at both sides of the unit.
 6. Tilt the mirrored glass into a vertical position.
 7. Secure the mirrored glass bracket to hold the glass in place, using the previously removed screws.
- ⚠ CAUTION:** Ensure the mirrored glass does not fall forward while the mirrored glass mounting bracket is being installed.
8. Remove the suction cup and clean any fingerprints or debris off the glass with a non-abrasive glass cleaner.
- ! NOTE:** Do not dispose of the suction cup! Keep it in a secure location, as it may be needed for maintenance and service on this fireplace.



Installation

Media Arrangement

For the best results when using the supplied media, follow the instructions below.

Tumbled Glass Media and Driftwood:

! **NOTE:** The driftwood is fragile. Ensure the driftwood is secure when placing it in the media bed, and keep a soft surface below the fireplace during installation.

1. Mix the different colours of tumbled glass in a bag or box of your choice.
1. Evenly disperse the tumbled glass media in the media tray. **(Figure 10)**
2. Place the driftwood pieces on top as desired. Examples shown in the images below. **(Figure 11, 12, 13)**

It is possible to use custom media ornaments to decorate your firebox. The custom media must fit easily without scratching the glass or bowing the media bed, and must not be composed of sand or liquid, which could interfere with the safety of the firebox.

Figure 10

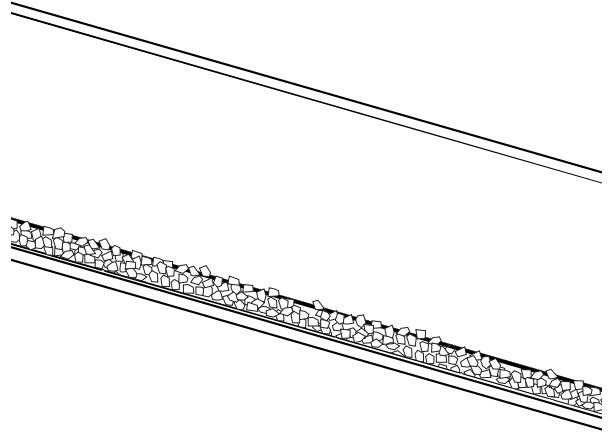

Figure 11



Figure 12

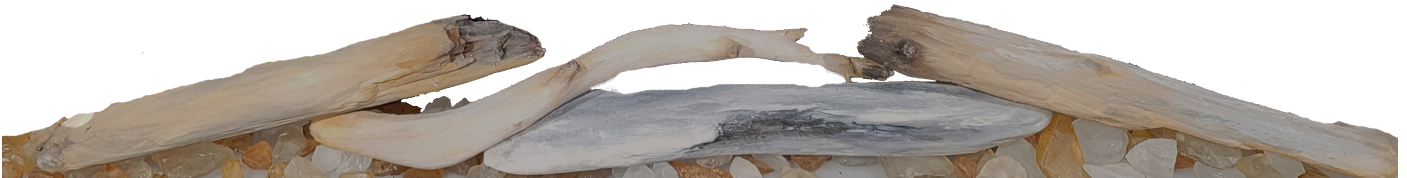

Figure 13



Front Glass Installation

- ! **NOTE:** Install the front glass before the fireplace is powered on. If the unit is powered on before the glass is installed, a full power reset will be required to activate the hidden touch controls.
1. Ensure that the mirrored glass and the inside of the front glass is clean and free from particles and fingerprints.
 2. Secure the suction cup (if provided) to the outside of the front glass.
 3. Lift the front glass and carefully place the front glass into the lip located at the bottom of the opening of the firebox.
 4. Tilt the glass into a vertical position.
 5. Secure the front glass using the provided screws and hex key.
- ⚠ **CAUTION:** Ensure the front glass does not fall forward while the securing screws are being installed.
6. Install the provided screw covers by placing the tabs of the screw cover between sides of the front glass bracket. (Figure 15)
- ! **NOTE:** Do not dispose of the suction cup and hex key! Keep them in a secure location, as it may be needed for maintenance and service on this fireplace.

Figure 14

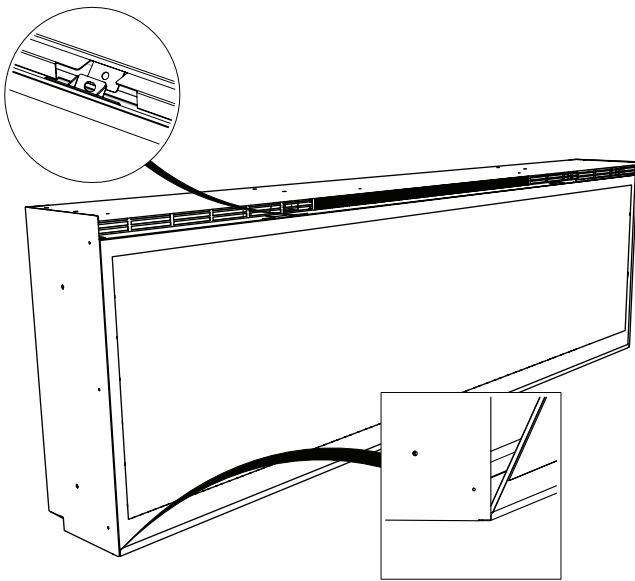
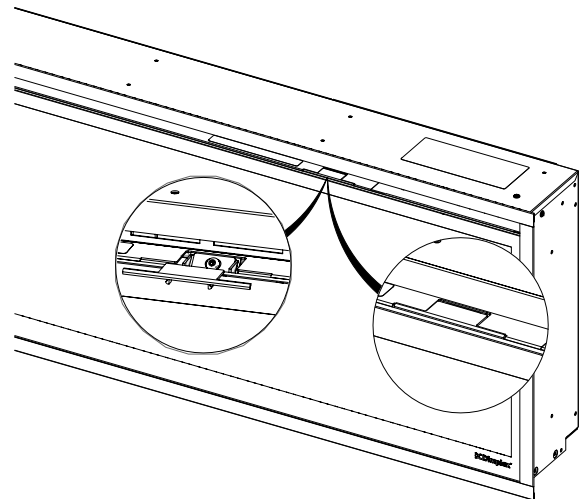

Figure 15



General Operation

⚠ WARNING: This electric firebox must be properly installed before it is used.

This firebox operates with ComfortSaver™ technology, which automatically adjusts the fan speed and heater wattage to safely and precisely match the requirements of the room based on the thermostat setting. The heater operates such that once the room reaches the set point, the fan and heater will continuously run at a low level, to maintain the desired room temperature. If the temperature in the room rises significantly, the heater will turn off and periodically turn back on to circulate the air around the unit, until the room temperature drops and requires the heater to be on again.

! NOTE: The element retains heat after shutdown. When the heat is turned off, there is a 2-minute cool down period before the fan shuts off completely.

! NOTE: The fireplace will retain the previously used settings after a power interruption.

Hidden Touch Controls

The hidden touch controls are located on the upper right of the fireplace. (Figure 16)

Remote Operation

The fireplace is supplied with a multifunction IR remote control. (Figure 17)

! NOTE: To operate correctly, the remote control must be pointed toward the front of the unit.

App

The fireplace is capable of being controlled using the Flame Connect app for mobile devices. For up-to-date information about the app, please visit www.dimplex.com/fcapp

Figure 16

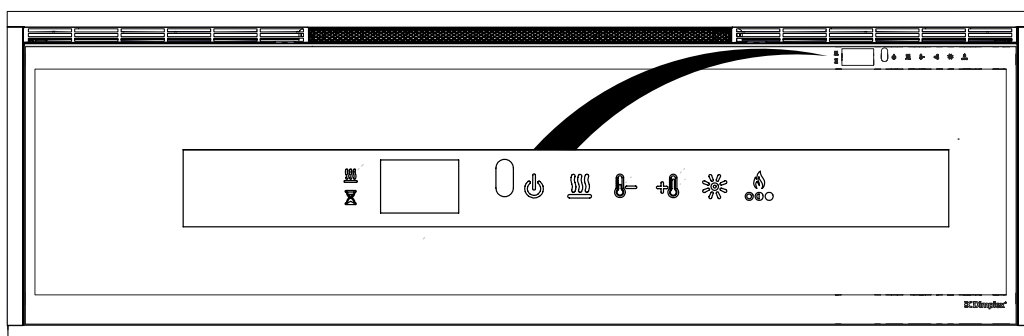
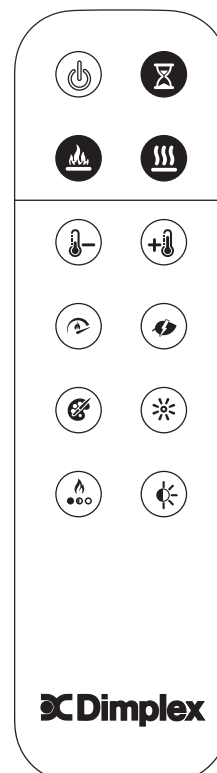









































Figure 17



Operation

	Standby	Press  to turn on the unit or to put it in standby mode. When the unit is turned back on, it will retain the previously used settings.
	Flame Effect	Press  to turn the flame effect and media on or off.
	Heat	Press  to turn the heat on or off. The fireplace will beep once and the  icon will remain on the display when activated. The fireplace can be operated in heat only mode by turning off the flame and color effects.
	Heat Disable	Press and hold  and  at the same time for 3 seconds to disable or enable the heat function. This action must be performed on the hidden touch controls . When the heat is disabled and either the  ,  , or  is pressed, --- will appear on the display.
	Temperature Increase	Press  to increase the temperature setting.
	Temperature Decrease	Press  to decrease the temperature setting.
		The temperature can be set from 7° C to 30° C (45° F to 86° F). When the temperature setting is adjusted, the set temperature will flash for 2 seconds, then the ambient room temperature will be displayed briefly.
	Temperature Display (°C ↔ °F)	Press and hold  and  at the same time for 3 seconds to toggle between Fahrenheit and Celcius. This action must be performed on the hidden touch controls .
	Flame Speed	Press  repeatedly to cycle through the 5 different flame speeds.
	Heat Mode	Press  repeatedly to cycle through the 4 different heater modes: Normal: The element will automatically adjust itself to achieve and maintain the set temperature. Heat Boost: The element will work at maximum power for 20 minutes, then revert to normal heater mode. Eco: The element will work at reduced power to save energy. Fan: The element will turn off and only the fan will run.
	Mood Themes	Press  repeatedly to cycle through the 8 different Moods, which are different color options for the media bed lighting. 1 - White 2 - Blue 3 - Violet 4 - Red 5 - Green 6 - Prism — media cycles through colors 7 - Kaleidoscope— media and accents cycle through colors at different rates 8 - Midnight mode — media is off Press and hold  to turn the media accent lights on or off.
	Custom Color	Freeze the media and accent lights to a custom color. When in Prism or Kaleidoscope modes (see Moods), press  while the desired color is displayed to freeze the cycle on that color. Press  again to resume the color cycle.

Operation

	Brightness	Press  repeatedly to cycle through the brightness and flicker modes. Solid <i>H</i> - High Brightness Solid <i>L</i> - Low Brightness Cycle <i>H</i> - High Brightness with flickering media and accent lights Cycle <i>L</i> - Low Brightness with flickering media and accent lights
	Flame Themes	Press  repeatedly to cycle through the 7 different flame themes: 1 - Base with orange and blue accents 2 - Base with orange accents 3 - Base with blue accents 4 - Blue 5 - Orange 6 - Base 7 - Orange and blue
	Ambient Light Sensor	Press  to turn the ambient light sensor on or off. The ambient light sensor will automatically adjust the brightness of the fireplace lights based on the ambient light in the room.
	Timer	Press  repeatedly until the desired number of hours of the timer is displayed. When this function is active, the fireplace will turn off after a set amount of time. The timer can be set from 30 minutes (display will show .5) to 8 hours in intervals of 30 minutes. To turn the timer off, press  repeatedly until  appears on the display. While the timer is active, press the timer button to see the time remaining.
	Factory Reset	Press and hold  and  at the same time for 3 seconds to reset all the settings to factory default. This action will also disconnect the unit from the Wi-Fi network if connected. This action must be performed on the hidden touch controls .

Maintenance

Remote Control Battery Replacement

1. Remove battery cover of the remote control using a Phillips screwdriver.
2. Correctly install the 3 Volt (CR2032 or similar) battery in the battery holder with the + side facing up.
3. Secure the battery cover using the previously removed screw.



Batteries must be recycled or disposed of properly. Check with your Local Authority or Retailer for recycling advice in your area.

Figure 18

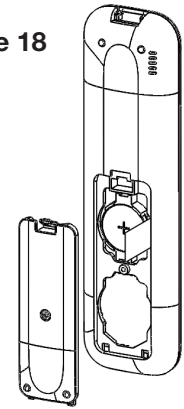

⚠ WARNING: Disconnect power and allow heater to cool before attempting any maintenance or cleaning to reduce the risk of fire, electric shock or injury to persons.

Cleaning

Mirrored Glass Cleaning

The mirrored glass is cleaned in the factory during the assembly operation. During shipment, installation, handling, etc., the mirrored glass may collect dust particles; these can be removed by dusting lightly with a clean dry cloth.

To remove fingerprints or other marks, the mirrored glass can be cleaned with a damp cloth. The mirrored glass should be completely dried with a lint-free cloth to prevent water spots. To prevent scratching, do not use abrasive cleaners.

Fireplace Surface Cleaning



Use only a damp cloth to clean painted surfaces of the fireplace. Do not use abrasive cleaners.

The fireplace should not be operated with an accumulation of dust or dirt on or in the unit, as this can cause a build-up of heat and eventual damage. For this reason the heater must be inspected regularly, depending upon conditions and at a minimum yearly intervals.

Servicing

Except for installation and cleaning described in this manual, an authorized service representative should perform any other servicing.

Troubleshooting

Problem	Display	Cause	Solution
Fireplace does not turn on with the hidden touch controls	N/A	No incoming power	Ensure unit is receiving power Check socket switch is on Ensure mains switch is on
		Front glass was installed after unit was powered on	Turn power off (from breaker or outlet), install front glass before turning power back on.
Fireplace does not turn on with the remote control	N/A	The battery in the remote control is dead or installed incorrectly	Replace remote control battery Ensure battery is installed with + facing up.
Heater does not turn on	---	Heater is disabled	Press and hold  and  at the same time on the hidden touch controls for 3 seconds to disable or enable the heat function.
	H--	Heater has been permanently disabled	If installation with heat is desired, reinstall jumper on main board if available or purchase new main board.
Heater is on, but there is no heat		Normal operation — There is a 30-second delay before heater starts	No action required.
		Thermostat setting is below ambient temperature	Turn up the thermostat setting to be above ambient temperature
Circuit breaker trips or fuse blows when unit is turned on	N/A	Improper circuit current rating	Install unit on a dedicated minimum 13 amp circuit.
Error Code is displayed	Err 1	Temperature cut-out is activated	Reset breaker and wait 5 minutes before turning unit back on it. If error persists, see Service Manual.
	Err 2	L1 voltage is too high	If error persists, consult an electrician.
	Err 3	L1 voltage is too low	If error persists, consult an electrician.
	Err 4	L1 current is too high	If error persists, consult an electrician.
	Err 12	Ambient temperature is above 45° C (113° F)	No action required.
	Err 13	Ambient temperature is below 5° C (41° F)	No action required.

For more troubleshooting, consult the Service Manual.

RECYCLING



At the end of the electrical products useful life it should not be disposed of with household waste. Please recycle where facilities exist. Check with your Local Authority or retailer for recycling advice in your area.